

# PURIFICARE, DEDURIZARE, FILTRARE, DEZINFECTARE APA



# CATALOG

- 2012 -

*Oradea jud. Bihor  
Str. V. Alecsandri nr 6  
J/05/801/2006  
RO 18574871*

*Banca Transilvania sucursala Oradea  
IBAN: RO 78 BTRL 0050 1202 R23653 XX  
Tel: 0748-270543 Fax: 0727 745 541*

[www.perpetuumnatural.com](http://www.perpetuumnatural.com)

[office@perpetuumnatural.com](mailto:office@perpetuumnatural.com)

**Preturile nu includ TVA.  
Preturile nu includ transportul**

**Pagina:1**

# PURIFICARE, DEDURIZARE, FILTRARE, DEZINFECTARE APA



FHPR5



FHPR34-N



FHHOT-1



FHPR34-V



F10SS1FS

Model	Descriere	Dimensiuni	Presiune maxima bari	Pret €/buc.
FHHOT-1	Carcasa filtru pentru apa calda (max.93° C)	10" x 3/4"	8,6	
FHPR34-V	Carcasa filtru transparent cu supapa de aerisire si cu robinet de golire	10" x 3/4"	6	16,83
F10SS1FS	Carcasa inox , cheie carcasa si suport	10" x 1"	8,6	102,45
FH20B1	Carcasa filtru BigBlue	20" x 1"	6	44,91
FH20B64	Carcasa filtru BigBlue	20" x 6/4"	6	45,80
FH10B1	Carcasa filtru BigBlue	10" x 1"	6	29,07



FXWR1



FXBR1



FXBR1BB

Model	Descriere	Dimensiuni	Presiune maxima bari	Pret €/buc.
FH10B1	Filtru cu carcasa din cupru si interior din otel de calitate	3/4" x 100 micrometri	2-93 °C	10,3
FH20B1	Cheie carcasa filtru*			1,26
FHMB12	Filtru cu carcasa din cupru si interior din otel de calitate cu manometru	1/2" x 100 micrometri	2-45 °C	10,3
FHMB34	Filtru cu carcasa din cupru si interior din otel de calitate cu manometru	3/4" x 100 micrometri	2-45 °C	10,3
FHMB1	Filtru cu carcasa din cupru si interior din otel de calitate cu manometru	1" x 100 micrometri	2-45 °C	10,3

Preț TVA.  
Preț transportul

Pagina:2



FHMC34FF

# PURIFICARE, DEDURIZARE, FILTRARE, DEZINFECTARE APA



FHMB34



FFPR34



FHMB34+FFPR1



FF06B-V



FFPR34-M

FHMMB64	Filtru cu carcasa din cupru si interior din otel de calitate cu manometru	6/4" x 100 microni	2-98 °C	16	
FHMB2	Filtru cu carcasa din cupru si interior din otel de calitate cu manometru	2" x 100 microni	2-98 °C	16	
FFPR34	Reductor de presiune cu carcasa din cupru, cu reglare intre 0,5-4 bari	3/4"	2-80 °C	15	38,45
FHMB34 FFPR34	Filtru cu carcasa din cupru si interior din otel de calitate cu manometru, cu reductor de presiune	3/4" x 100 microni	2-45 °C	10,3	57,69
FF06B-V	Filtru transparent cu cap din cupru, cu robinet de golire	Int.3/4" / Ext. 1" 80 microni	2-45 °C	15	24,78
FFPR34-M	Reductor de presiune cu carcasa din cupru, cu reglare intre 0,5- 4 bari cu manometru	3/4"	2-80 °C	15	41,57
FF06B-V FFPR34-M	Filtru transparent cu cap din cupru, cu robinet de golire, reductor de presiune cu carcasa din cupru, cu reglare intre 0,5-4 bari, manometru	3/4"	2-45 °C	15	66,32

# PURIFICARE, DEDURIZARE, FILTRARE, DEZINFECTARE APA



Model	Descriere	Racordare	Debit	Presiune/ Temperatura	Dimensiuni ( L x H )	Pret€ /buc.
OTS-FB072	Filtru cu cap din cupru si cu cartus filtrant lavabil de 10" x 2.5"	6/4"	10m <sup>3</sup> /h	8 bar / 40°C	150 x 335 mm	113,00
OTS-FB066	Filtru cu cap din cupru si cu cartus filtrant lavabil de 10" x 2.5"	2"	15m <sup>3</sup> /h	8 bar / 40°C	161 x 620 mm	158,93

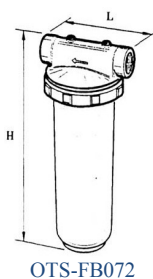

OTS-FB072



NW-FB408

Model	Descriere	Racordare	Debit	Presiune/ Temperatura	Dimensiuni ( L x H )	Pret € /buc.
NW-FB408	Filtru sedimente uz industrial cu valva de golire, manometru si cartus filtrant lavabil de 25 de microni	2"	20m <sup>3</sup> /h	10 bar / 50°C	240 x 693 mm	387,48
NW-FB409	Filtru sedimente uz industrial cu valva de golire, manometru si cartus filtrant lavabil de 25 de microni	2 1/2"	25m <sup>3</sup> /h	10 bar / 50°C	240 x 693 mm	398,79
NW-FB410	Filtru sedimente uz industrial cu valva de golire, manometru si cartus filtrant lavabil de 25 de microni	3"	30m <sup>3</sup> /h	10 bar / 50°C	240 x 693 mm	413,69
NW-FB	Cartus filtrant lavabil rezerva					26,49

**Preturile nu includ TVA.  
Preturile nu includ transportul**

Model	Descriere	Finete	Pret € /buc.
FCPS1-5*	Cartus filtrant PP 5" x 2.5"	1 micron	1,32
FCPS5-5*	Cartus filtrant PP 5" x 2.5"	5 microni	1,32
FCPS20-5*	Cartus filtrant PP 5" x 2.5"	20 microni	1,32
FCPS50-5*	Cartus filtrant PP 5" x 2.5"	50 microni	1,32

**Pașma:4**

# PURIFICARE, DEDURIZARE, FILTRARE, DEZINFECTARE APA



FCPS



FCPP



FCPNN



FCCBL



FCPS5M20B

FCPS1*	Cartus filtrant PP 10" x 2.5"	1 micron	1,56
FCPS5*	Cartus filtrant PP 10" x 2.5"	5 microni	1,56
FCPS20*	Cartus filtrant PP 10" x 2.5"	20 microni	1,56
FCPS50*	Cartus filtrant PP 10" x 2.5"	50 microni	1,56
FCPS1-L*	Cartus filtrant PP 20" x 2.5"	1 micron	5,22
FCPS5-L*	Cartus filtrant PP 20" x 2.5"	5 microni	5,22
FCPS20-L*	Cartus filtrant PP 20" x 2.5"	20 microni	5,22
FCPS50-L*	Cartus filtrant PP 20" x 2.5"	50 microni	5,22
FCPS1-30*	Cartus filtrant PP 30" x 2.5"	1 micron	8,97
FCPS5-30*	Cartus filtrant PP 30" x 2.5"	5 microni	8,97
FCPS1-40*	Cartus filtrant PP 40" x 2.5"	1 micron	11,97
FCPS5-40*	Cartus filtrant PP 40" x 2.5"	5 microni	11,97
FCPP1 *	Cartus filtrant cu bumbac 10" x 2.5"	1 micron	2,07
FCPP5 *	Cartus filtrant cu bumbac 10" x 2.5"	5 microni	2,07
FCPP20 *	Cartus filtrant cu bumbac 10" x 2.5"	20 microni	2,07
FCPP50 *	Cartus filtrant cu bumbac 10" x 2.5"	50 microni	2,07
FCPNN50M*	Cartus filtrant PP lavabil 10" x 2.5"	50 microni	7,95
FCPNN100M*	Cartus filtrant PP lavabil 10" x 2.5"	100 microni	7,80
FCPNN150M*	Cartus filtrant PP lavabil 10" x 2.5"	150 microni	7,74
FCPHH100M*	Cartus lavabil 10" x 2.5" apa calda	100 microni	27,09
FCCBL5*	Cartus filtrant cu carbon activat 5" x 2.5"	10 microni	1,62
FCCBL*	Cartus filtrant cu carbon activat 10" x 2.5"	10 microni	3,93
FCCBKDF*	Cartus filtrant KDF 10" x 2.5"	10 microni	9,03
FCCER*	Cartus filtrant ceramic 10" x 2.5"	0.3 microni	11,79

# PURIFICARE, DEDURIZARE, FILTRARE, DEZINFECTARE APA



Model	Descriere	Finete	Pret €/buc.
FCEB-10*	Canistra cartus filtrant		3,87
FCPS1M20B*	Cartus filtrant PP BigBlue 20" x 4"	1 microni	15,90
FCPS5M20B*	Cartus filtrant PP BigBlue 20" x 4"	5 microni	15,90
FCPS20M20B*	Cartus filtrant PP BigBlue 20" x 4"	20 microni	15,90
FCPS50M20B*	Cartus filtrant PP BigBlue 20" x 4"	50 microni	15,90
FCCBL20BB*	Cartus filtrant carbune activ BigBlue 20" x 4"	10 microni	38,49
RFFE20BB*	Cartus filtrant deferezare BigBlue 20" x 4"	30 microni	194,40
FCPS1M10B*	Cartus filtrant PP BigBlue 10" x 4"	1 micron	10,5
FCPS5M10B*	Cartus filtrant PP BigBlue 10" x 4"	5 microni	10,5
FCPS20M10B*	Cartus filtrant PP BigBlue 10" x 4"	20 microni	10,5



FCPS5M10B



TDS-79



PH600



OKT-1

Model	Descriere	Parametrii	Pret € /buc.
TDS-79	Aparat de masurat concentratia de saruri	saruri (ppm)	35,06
PH600	Aparat de masurat pH	pH	73,26
OKT-1	Indicator duritate totala apa	Duritate totala (grade germane)	9,48
9CPT-2*	Indicator pastile pH-clor	pH Clor liber(mg/l)	5,73
FXT-AQ	Set ptr. testare de unica folosinta	pH si alcalinitate, duritate, fier, clor	6,42
FXT-1-AQ	Set ptr. testare de unica folosinta	pH si alcalinitate, clor, duritate	4,53
	Set ptr. testare de unica folosinta		

Pre  
Pret

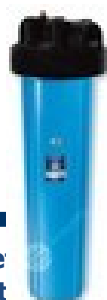

FH20B1 + FCCBL20BB



FHPR12 + FCCBL



FHCTF



EKOPF4



EKOPF4-PLUS

# PURIFICARE, DEDURIZARE, FILTRARE, DEZINFECTARE APA



Model	Descriere	Racordare int./ies.	Pret € /buc.
FH20B1 FCCBL20BB	Filtru cu carbune activat pentru intreaga locuinta, cheie filtru, consol, cartus (FCCBL20BB)	1"	87,83
FHPR12 FCCBL	Filtru cu carbune activat pentru bucatarii montat sub teighea, cheie filtru, consol, cartus (FCCBL)	1/2"	17,55
FHCTF	Filtru de bucatarie montat "pe teighea" (cu filtru: FCCA-STO)	robinet separat	29,30
EKOPF4	Filtru de bucatarie montat "sub teighea" (cu filtre: FCPS20-CN, FCCBL-CN, FCPS5-CN, FCCBL-CN),	robinet separat	60,75
EKOPF4-PLUS	Filtru de bucatarie montat "sub teighea" (cu filtre: FCPS20-CN, FCCBL-CN, FCPS5-CN, TLCHF),	robinet separat	74,43
FCCA-STO*	Cartus filtrant ptr.filtrul de bucatarie FHCTF		4,71
FCPS20-CN*	Cartus filtrant ptr. filtrele EKOPF4 si EKOPF4 - PLUS		1,71
FCPS5-CN*	Cartus filtrant ptr. filtrele EKOPF4 si EKOPF4 - PLUS		1,71
FCCBL-CN*	Cartus filtrant ptr. filtrele EKOPF4 si EKOPF4 - PLUS		3,42
TLCHF	Cartus filtrant ptr. filtrele EKOPF4 si EKOPF4 - PLUS		21,05

**Preturile Preturile**



FHSH-1



FCSH-1



FHSH-5-C



FHSH-6-C



FCSH-56\_K

**pagina:7**

# PURIFICARE, DEDURIZARE, FILTRARE, DEZINFECTARE APA



Model	Descriere	Racordare	Pret € /buc.
FHSH-1	Filtru dus ptr. eliminarea clorului cu cartus filtrant (FCSH-1)	1/2"	18,93
FHSH-5-C	Telefon dus cromat, imbinat cu filtru ptr. eliminarea clorului	1/2"	15,42
FHSH-6-C	Telefon dus cromat, imbinat cu filtru ptr. eliminarea clorului	1/2"	18,23
FCSH-1	Cartus filtrant schimb ptr.filtrele FHSH-1	-	6,89
FCSH-56_K	Cartus filtrant schimb ptr.filtrele FHSH-5-C si FHSH-6-C	-	5,63



VTFRO5M



VTFRO5MP



RO600GPM

Model	Descriere	Performanta	Pret € /buc.
VTFRO5M	Purificator apa pe baza de „Osmoza Inversa” (cu filtre: FCPS20, FCCBL, FCPS5, AIMRO, AICRO, TLC75F)	2-5 litri/h	182,25
VTFRO5MP	Purificator apa pe baza de „Osmoza Inversa” cu pompa de presiune (cu filtre: FCPS20, FCCBL, FCPS5, AIMRO, AICRO, TLC75F)	5-10 litri/h	331,83
RO600GPM	Purificator apa pe baza de „Osmoza Inversa” (cu filtre: AIPRO-20MS,, AIPRO-1MS, 2 buc. AICRO-L3, 2 buc TFC300)	30-50 litri/h	560,78



AIMRO



AICRO



AIFIR



AIPRO-20MS



AIPRO-1MS



AICRO-L3



TLC75F



TFC-300

# PURIFICARE, DEDURIZARE, FILTRARE, DEZINFECTARE APA



Model	Descriere	Performanta	Pret € /buc.
AIMRO*	Patron de remineralizare ptr. purificatoarele VTFRO5M si VTFRO5MP	-	10,59
AICRO*	Postfiltru cu carbon activat ptr. purificatoarele VTFRO5M si VTFRO5MP	10 microni	9,36
AIFIR*	Patron bioceramic ptr. purificatoarele VTFRO5M si VTFRO5MP	-	19,25
AIPRO-20MS*	Prefiltru ptr. purificatoarele RO600GPM	20 microni	43,38
AIPRO-1MS*	Prefiltru ptr. purificatoarele RO600GPM	1 micron	
AICRO-L3*	Prefiltru cu carbune activat ptr. purificatoarele RO600GPM	10 microni	
TLC75F	Membrana osmoza ptr. purificatoarele VTFRO5M si VTFRO5MP	75GPH	46,74
TFC-300	Membrana osmoza ptr. purificatoarele RO600GPM	300GPH	143,72



WI-2



FP2

Model	Descriere	Performanta	Pret €/buc.
WI-2	Aparat ptr. alcalinizare cu set pentru montare, cu ultrafiltru(TLCHF-4)	100 litri/h	550,20
TLCHF-4	Cartus filtrant ptr. aparatele WI-2	0.02 microni	31,10
FP-2	Filtru de bucatarie "sub teighea" (cu filtre: FCCBL, FCPS5,) cu robinet si set de instalare	100-200 litri/h	50,97



WF-1



FXFCH4



FXFCH5



FUV-P5



P5-GT

Preturile nu in  
Preturile nu in

# PURIFICARE, DEDURIZARE, FILTRARE, DEZINFECTARE APA



Model	Descriere	Pret €/buc.
WF-1	Robinet ptr. apa rece, apa calda si apa purificata ptr. purificatoarele de apa VTFRO5M, VTFRO5MP, RO600GPM	111,96
FXFCH4	Robinet apa purificata ptr. aparatele VTFRO5M si VTFRO5MP, FP2, EKOPF4, EKOPF4-PLUS	24,08
FXFCH5	Robinet apa purificata ptr. aparatele VTFRO5M si VTFRO5MP, FP2, EKOPF4, EKOPF4-PLUS	19,88
FUV-P5	Sterilizator uv ptr. purificatoarele VTFRO5M si VTFRO5MP	87,62
P5-GT	Lampa UV rezerva ptr. sterilizator FUV-P5	30,14



PRO4000W



PRO42000



PRO77000



PDEZYN

Model	Descriere	Performanta	Pret € /buc.
PRO4000W	Tanc rezervor cu membrana din cauciuc ptr. purificatoarele RO, plastic, alb	15 litri	65,43
PRO42000N	Tanc rezervor cu membrana din cauciuc ptr. purificatoarele RO, metal, albastru	42 litri	129,68
PRO77000N	Tanc rezervor cu membrana din cauciuc ptr. purificatoarele RO, metal, albastru	76 litri	161,22
PDEZYN	Set dezinfectare purificatoare apa	-	14,84
SRODEZYN*	Granulat ptr. dezinfectarea aparatelor VTFRO5M si VTFRO5MP		0,84



AFDL-RO4-75



AFDL-2G

**Preturile nu includ TVA.  
Preturile nu includ transport**

# PURIFICARE, DEDURIZARE, FILTRARE, DEZINFECTARE APA



Model	Descriere	Performanta	Dimensiuni (mm) i x l x g	Model filtre si membrana	Pret€ /buc.
AFDL-RO4-75	Dozator de apa imbinat cu purificator de apa cu Osmoza Inversa	2 – 10 litri/h	1040 x 440 x 320	FCPS20, AICRO, AIMRO TLC75F	684,14
AFDL-2G	Dozator de apa imbinat cu purificator de apa cu filtru capilar	2 – 10 litri/h	990 x Ø 315	AIPRO-1MS, AISTRO-L, AICRO-L3, AIPRO5, TLCHF-FP	874,80

AIPRO-1MS*	Prefiltru ptr. dozatorul AFDL-2G	37,38
AISTRO-L*	Prefiltru ptr. dozatorul AFDL-2G	
AICRO-L3*	Prefiltru cu carbune activat ptr. dozatorul AFDL-2G	
AIPRO-5*	Prefiltru ptr. dozatorul AFDL-2G	
TLCHF-FP	Membrana capilara ptr. dozatorul AFDL-2G	30,86
FCPS20*	Prefiltru ptr. dozatorul AFDL-RO4-75	21,51
AICRO*	Prefiltru cu carbune activat ptr. dozatorul AFDL-RO4-75	
AIMRO*	Prefiltru ptr. dozatorul AFDL-RO4-75	
TLC75F	Membrana osmoza ptr. dozatorul AFDL-RO4-75	46,74

Model	Descriere	Perfor- manta	Dimensiuni (mm) i x l x g	Volum aer/ Nivel de zgomot maxim	Pret € /buc.
-------	-----------	------------------	---------------------------	----------------------------------	--------------

Preturile nu includ TVA.  
Preturile nu includ transportul

# PURIFICARE, DEDURIZARE, FILTRARE, DEZINFECTARE APA



AP-1	Purificator aer, cu generator de ioni negativi si cu telecomanda (cu filtre AP1-ULPA, AP1-C, AP1-UV, AP1-AROM I)	60W	510 x 360 x 180	70 m3/h< 39 dB 180 m3/h< 45 dB 250 m3/h< 53 dB	223,92
AP-2	Purificator aer, cu generator de ioni negativi si cu telecomanda (cu filtre AP2-ULPA, AP2-C, AP2-UV )	40W	300 x 170 x 320	40 m3/h< 25dB 60 m3/h< 35dB 120 m3/h< 40dB	136,85
AP-3	Purificator aer, cu tehnologie plazma si cu telecomanda (cu filtre AP3-TIO2)	76W	526 x 210 x 409	250 m3/h<35 dB	266,22



**AP-1**



**AP-2**



**AP-3**

Model	Descriere	Pret €/buc.
AP1-ULPA AP1-C	Set filtre de schimb (2buc AP1-ULPA filtru ptr. eliminarea bacteriilor, 2buc AP1-C filtru carbon activat)	17,42
AP1-UV	Set lampa UV de schimb (2buc AP1-lampa UV)	7,47
AP1-Arom	Odorizant ptr. aromaterapie	0,99
AP2-ULPA AP2-C	Set filtre de schimb (1buc AP2-ULPA filtru ptr. eliminarea bacteriilor, 1buc AP2-C filtru carbon activat)	9,95
AP2-UV	Lampa UV de schimb	3,74
AP-3-TIO2	Filtru de schimb	35,58
AP3-UV	Lampa UV de schimb	3,74

**Preturile nu includ  
Preturile nu includ**



FHPRA



FHPRA-1



FCPRA-10

**jina:12**

# PURIFICARE, DEDURIZARE, FILTRARE, DEZINFECTARE APA



Model	Descriere	Racordare	Pret €/buc.
FHPRA	Filtru anticalcar pentru protejarea masinilor de spalat	3/4"	8,90
FHPRA-34	Filtru anticalcar cu cartus filtrant FCPRA-10	3/4"	24,66
FHPRA-1	Filtru anticalcar cu cartus filtrant FCPRA-10	1"	25,00
FCPRA-10	Cartus filtrant anticalcar rezerva ptr. filtrele FHPRA-34 si FHPRA-1	-	12,63



WFD-12

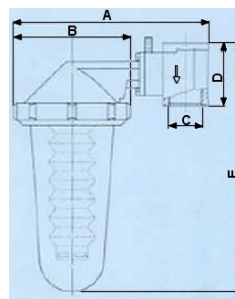

Model	Descriere	A	B	C	D	E	Racordare	Pret € /buc.
WFD-12	Dozator polifosfat ptr. protejarea cazanelor, boilerelor, masinilor de spalat	140	70	1/2"	60	140	1/2"	32,66
WFD-34	Dozator polifosfat ptr. protejarea cazanelor, boilerelor, masinilor de spalat	170	110	3/4"	60	240	3/4"	106,08
WFD-1	Dozator polifosfat ptr. protejarea cazanelor, boilerelor, masinilor de spalat	170	110	1"	60	240	1"	111,78
WF500	Praf polifosfat 500g.	-	-	-	-	-	-	10,94

Model	Descriere	Valva de comanda	Racordare	Dimensiuni	Rasina litri	Debit	Pret € /buc.
-------	-----------	------------------	-----------	------------	--------------	-------	--------------

Preturile nu includ TVA.  
Preturile nu includ transportul

# PURIFICARE, DEDURIZARE, FILTRARE, DEZINFECTARE APA



BlueSoft-10-HR34	Dedurizator ptr. protejarea aparatelor uz casnic si semi industrial	RX semi-automata	3/4"	460 x 195 x 405	5	0.2 - 0.5	270,86
BlueSoft-10-TR34	Dedurizator ptr. protejarea aparatelor uz casnic si semi industrial	RX dupa timp	3/4"	460 x 195 x 405	5	0.2 - 0.5	318,20
BlueSoft-10-VR34	Dedurizator ptr. protejarea aparatelor uz casnic si semi industrial	RX dupa volum	3/4"	460 x 195 x 405	5	0.2 - 0.5	340,16



BlueSoft-10



Statie de dedurizare cu cabinet **BlueSoft**



Statii de dedurizare **BlueSoft**

Model	Seria BlueSoft seria <b>S</b>	Valva de comanda	Racordare int./ies.	Dimensiuni (mm)	Rasina litri	Debit m <sup>3</sup> /h	Pret € /buc.
				I x L x G			
BlueSoft-K50-STR34	Statie de dedurizare uz casnic	RX LED Control dupa timp	3/4"	670 x 320 x 500	12.5	1.0 – 1.5	380,55
BlueSoft-K70-STR34	Statie de dedurizare uz casnic	RX LED Control dupa timp	3/4"	1140 x 320 x 500	18	1.5 – 2.0	456,29
BlueSoft-K100-STR34	Statie de dedurizare uz casnic	RX LED Control dupa timp	3/4"	1140 x 320 x 500	25	2.0 – 2.5	487,25
BlueSoft-K50-SVR34	Statie de dedurizare uz casnic	RX LED Control volumetric	3/4"	670 x 320 x 500	12.5	1.0 – 1.5	402,51
BlueSoft-K70-SVR34	Statie de dedurizare uz casnic	RX LED Control volumetric	3/4"	1140 x 320 x 500	18	1.5 – 2.0	478,25
BlueSoft-K100-SVR34	Statie de dedurizare uz casnic	RX LED Control volumetric	3/4"	1140 x 320 x 500	25	2.0 – 2.5	509,21

Model	Seria BlueSoft seria <b>G</b>	Valva de comanda	Racordare int./ies.	Dimensiuni (mm)	Rasina litri	Debit m <sup>3</sup> /h	Pret € /buc.
				I x L x G			

Preturile nu includ TVA.  
Preturile nu includ transportul

# PURIFICARE, DEDURIZARE, FILTRARE, DEZINFECTARE APA



BlueSoft-K30-VR34	Statie de dedurizare uz casnic, bloc montaj inclus, supapa de prot. preaplin	RX LED Control dupa timp si volum	3/4"	670 x 320 x 500	8	0.8 – 1-2	407,54
BlueSoft-K50-VR34	Statie de dedurizare uz casnic, bloc montaj inclus, supapa de prot. preaplin	RX LED Control dupa timp si volum	3/4"	670 x 320 x 500	12,5	1.0 – 1.5	424,88
BlueSoft-K70-VR34	Statie de dedurizare uz casnic, bloc montaj inclus, supapa de prot. preaplin	RX LED Control dupa timp si volum	3/4"	1140 x 320 x 500	18	1.5 – 2.0	500,61
BlueSoft-K100-VR34	Statie de dedurizare uz casnic, bloc montaj inclus, supapa de prot. preaplin	RX LED Control dupa timp si volum	3/4"	1140 x 320 x 500	25	2.0 – 2.5	531,57
BlueSoft-N50-VR1	Statie de dedurizare uz casnic, bloc montaj inclus, supapa de prot. preaplin	RX LED Control dupa timp si volum	1"	670 x 320 x 500	12,5	1.0 – 1.5	480,14
BlueSoft-N100-VR1	Statie de dedurizare uz casnic, bloc montaj inclus, supapa de prot. preaplin	RX LED Control dupa timp si volum	1"	1140 x 320 x 500	25	2.0 – 2.5	562,58
BlueSoft-N120-VR1	Statie de dedurizare uz casnic, bloc montaj inclus, supapa de prot. preaplin	RX LED Control dupa timp si volum	1"	1140 x 320 x 500	30	2.5 – 3	613,89
BlueSoft-BIO	Optie: sistem inclus pt. dezinfectarea patului de rasina	-	-	-	-	-	111,38

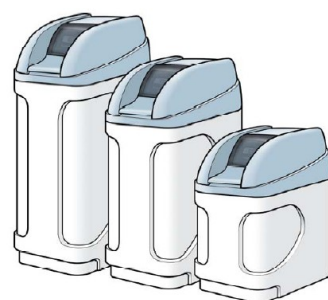

# PURIFICARE, DEDURIZARE, FILTRARE, DEZINFECTARE APA



Model	Seria BlueSoft seria <b>P</b>	Valva de comanda	Racordare int./ies.	Dimensiuni (mm)	Rasina litri	Debit m <sup>3</sup> /h	Pret € /buc.
				I x L x G			
BlueSoft-N50-PVR1	Statie de dedurizare uz casnic cu regenerare in contracurent , bloc montaj inclus, supapa de protectie preaplin	RX LED Control dupa timp si volum in contracurent	1"	670 x 320 x 500	12,5	1.0 – 1.5	480,14
BlueSoft-N100-PVR1	Statie de dedurizare uz casnic cu regenerare in contracurent , bloc montaj inclus, supapa de protectie preaplin	RX LED Control dupa timp si volum in contracurent	1"	1140 x 320 x 500	25	1.5 – 2.0	562,58
BlueSoft-N120-PVR1	Statie de dedurizare uz casnic cu regenerare in contracurent , bloc montaj inclus, supapa de protectie preaplin	RX LED Control dupa timp si volum in contracurent	1"	1140 x 320 x 500	30	2.5-3.0	613,89
BlueSoft-BIO	Optie: sistem inclus pt. dezinfectarea patului de rasina	-	-	-	-	-	111,38



Model	Descriere	Pret € /buc.
SZCS-1	Set instalare dedurizator, prefiltru 1" (FF06B-V), bloc montaj (MB-1) tub flexibil (FCS-400BB), indicator duritate totala (OKT-1).	193,10
SZCS-2	Set instalare dedurizator, prefiltru 1"cu reductor de presiune (FF06B-V-PR), tub flexibil (FCS-400BB), indicator duritate totala (OKT-1).	114,38
FF06B-V	Filtru transparent cu cap din cupru, cu robinet de golire	24,78
FF06B-V-PR	Filtru transparent cu cap din cupru, cu robinet de golire, reductor de presiune	66,32
MB-1	Bloc montaj	120,29
FCS-400BB	Tub flexibil (2 buc.), coturi	38,60
OKT-1	Indicator duritate totala apa (grade germane)	9,48

## CUM SA ALEGEM DEDURIZATOR

# PURIFICARE, DEDURIZARE, FILTRARE, DEZINFECTARE APA



Dedurizator oferit		Pe baza de consum de apa/ luna			
		1-3 persoane 5-10 m <sup>3</sup> /luna	3-4 persoane 10-15 m <sup>3</sup> /luna	4-5 persoane 20-25 m <sup>3</sup> /luna	6-8 persoane 30-35 m <sup>3</sup> /luna
Pe baza de duritate totala apa	Apa cu duritate totala intre 1 – 10 gG°	BlueSoft-30	BlueSoft-30	BlueSoft-50	BlueSoft-70
	Apa cu duritate totala intre 10 – 15 gG°	BlueSoft-30	BlueSoft-50	BlueSoft-70	BlueSoft-100
	Apa cu duritate totala intre 15 – 20 gG°	BlueSoft-50	BlueSoft-70	BlueSoft-100	BlueSoft-100
	Apa cu duritate totala intre 20 – 30 gG°	BlueSoft-70	BlueSoft-100	BlueSoft-100	BlueSoft-120

gG°= Duritate totala in grade germane

1. Racordare curent electric 230 VAC
2. Bloc montaj
3. Tub flexibil
4. Prefiltru
5. Valva de comanda
6. Tub preaplin
7. Cabinet dedurizator
8. Tub apa respalare
9. Drenaj

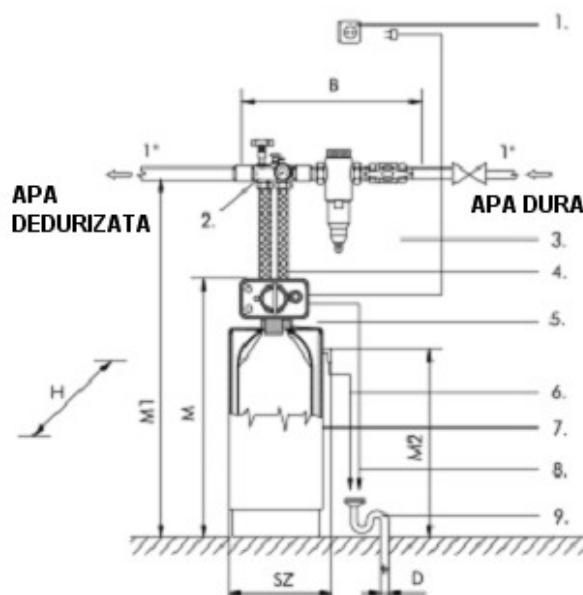

# PURIFICARE, DEDURIZARE, FILTRARE, DEZINFECTARE APA



Model	Descriere	Racordare	Performanta (W)	Nr. lampi	Dimensiuni mm L x D	Debit 30mJ/cm2 (m3/h)	Pret €/buc.
Aquazone SC4	Sterilizator UV	1/2"	17	1	462 x 65	0.9	210,28
Aquazone S5Q	Sterilizator UV	3/4"	25	1	560 x 65	1-4	321,83
Aquazone S8Q	Sterilizator UV	3/4"	37	1	900 x 65	2.3	501,39
Aquazone S12Q	Sterilizator UV	1"	39	1	940 x 89	3.4	658,79
Aquazone S24Q	Sterilizator UV	1"	78	2	940 x 178	6.8	1498,50
Aquazone	Sterilizator UV	de la 6/4" pana la 4"	-	-	-	-	La sollicitare



Aquazone model SC



Aquazone model SQ



Model	Descriere	Pret €/buc.
S330RL	Lampa UV rezerva SC4	64,29
S463RL	Lampa UV rezerva S5Q	66,74
S810RL	Lampa UV rezerva S8Q	88,52
S36RL	Lampa UV rezerva S12Q, S24Q	89,09

# PURIFICARE, DEDURIZARE, FILTRARE, DEZINFECTARE APA



## Statii de dedurizare monobloc cu valva de comanda dupa timp model "RX"

Model	Capacitate rasina litri/m <sup>3</sup> x gG <sup>o</sup>	Valva com. /racordare	Volum rezervor saramura ( l )	Debit m <sup>3</sup> /h	Sare kg/reg.	Dimen.(mm) l x l x i	Gre. kg	Pret € /buc.
BlueSoft 60T-RX	15 / 60	RX-65B-DTS 3/4"	85	0.6-1.2	3.6	650 x 500 x 1200	19	448,41
BlueSoft 120T-RX	30 / 120	RX-65B-DTS 3/4"	85	1.2-1.8	7.2	800 x 600 x 1200	36	542,25
BlueSoft 180T-RX	45 / 180	RX-65B-DTS 3/4"	85	1.8-2.4	10.8	800 x 600 x 1600	55	664,46
BlueSoft 240T-RX	60 / 240	RX-63B-DTS 1"	190	2.4-3.2	14.4	900 x 600 x 1500	69	815,7
BlueSoft 320T-RX	80 / 320	RX-63B-DTS 1"	190	3.2-3.8	19.2	900 x 600 x 1600	88	946,74
BlueSoft 400T-RX	100 / 400	RX-63B-DTS 1"	340	3.8-4.5	24	1100 x 700 x 2000	115	1263,24



## Statii de dedurizare monobloc cu valva de comanda dupa volum model "RX"

Model	Capacitate rasina litri/m <sup>3</sup> x nk <sup>o</sup>	Valva com. /racordare	Volum rezervor saramura ( l )	Debit m <sup>3</sup> /h	Sare kg/reg.	Dimen.(mm) l x l x i	Gre. kg	Pret € /buc.
BlueSoft 60V-RX	15 / 60	RX-65B-DVS 3/4"	80	0.6-1.2	3.6	650 x 500 x 1200	19	481,23
BlueSoft 120V-RX	30 / 120	RX-65B-DVS 3/4"	80	1.2-1.8	7.2	800 x 600 x 1200	36	557,09
BlueSoft 180V-RX	45 / 180	RX-65B-DVS 3/4"	130	1.8-2.4	10.8	800 x 600 x 1600	55	697,26
BlueSoft 240V-RX	60 / 240	RX-63B-DVS 1"	190	2.4-3.2	14.4	900 x 600 x 1500	69	852,21
BlueSoft 320V-RX	80 / 320	RX-63B-DVS 1"	190	3.2-3.8	19.2	900 x 600 x 1600	88	983,25
BlueSoft 400V-RX	100 / 400	RX-63B-DVS 1"	340	3.8-4.5	24	1100 x 700 x 2000	115	1299,77
BlueSoft 600V-RX	150 / 600	RX-74A-DVS 2"	460	5.0-7.0	36	1300 x 800 x 2100	170	2371,86
BlueSoft 800V-RX	200 / 800	RX-74A-DVS 2"	670	8.0-9.5	48	1500 x 900 x 2100	215	2802,14

# PURIFICARE, DEDURIZARE, FILTRARE, DEZINFECTARE APA



## Statii de dedurizare duplex cu valva de comanda dupa volum model "RX"

Model	Capacitate rasina litri/m <sup>3</sup> x nk <sup>0</sup>	Valva com. /racord.	Volum rezervor saramura ( l )	Debit m <sup>3</sup> /h	Sare kg/reg.	Dimen.(mm) l x l x i	Gre. kg	Pret € /buc.
BlueSoft 60VD-RX	2 x 15 / 2 x 60	RX-73AB-DVS1"	80	0.6-1.2	3.6	650 x 500 x 1200	38	912,6
BlueSoft 120VD-RX	2 x 30 / 2 x 120	RX-73AB-DVS1"	80	1.2-1.8	7.2	800 x 600 x 1200	72	1063,71
BlueSoft 180VD-RX	2 x 45 / 2 x 180	RX-73AB-DVS1"	130	1.8-2.4	10.8	800 x 600 x 1600	110	1268,99
BlueSoft 240VD-RX	2 x 60 / 2 x 240	RX-73AB-DVS1"	190	2.4-3.2	14.4	900 x 600 x 1500	138	1489,68
BlueSoft 320VD-RX	2 x 80 / 2 x 320	RX-73AB-DVS1"	340	3.2-3.8	19.2	900 x 600 x 1600	185	1680,98
BlueSoft 400VD-RX	2 x 100 / 2 x 400	RX-73AB-DVS1"	340	3.8-4.5	24	1100 x 700 x 2000	230	2191,71
BlueSoft 600VD-RX	2 x 150 / 2 x 600	RX-74AB-DVS2"	460	5.0-7.0	36	2500 x 850 x 2000	370	4978,58
BlueSoft 800VD-RX	2 x 200 / 2 x 800	RX-74AB-DVS2"	670	7.0-9.5	48	3200 x 950 x 2000	490	5839,11
BlueSoft 1200VD-RX	2 x 300 / 2 x 1200	RX-74AB-DVS2"	920	9.5-12	72	3500 x 950 x 2000	750	7790,67



BlueSoft-VD-RX



BlueSoft-FLM

## Sistem mobil de dedurizare pentru umplerea sistemelor de incalzire, cu valva de comanda model "RX"

Model	Descriere	Racordare	Volum rasina litri	Volum apa dedurizata	Gre. kg	Dimen.(mm) l x l x i	Pret € /buc.
BlueSoft 60FLM	Dedurizator pentru sisteme de incalzire, monobloc, valva de comanda semiautomata, rezervor saramura separata	3/4"	15	3 - 4 m3/ intre doua regenerari	18	Dim. tot. cu rez. 600 x 500 x 1050 Dim. mobil	307,88
BlueSoft 120FLM	Dedurizator pentru sisteme de incalzire, monobloc, valva de comanda semiautomata, rezervor saramura separata	3/4"	30	6 - 8 m3/ intre doua regenerari	30	Dim. tot. cu rez. 700 x 500 x 1050 Dim. mobil	376,91

# PURIFICARE, DEDURIZARE, FILTRARE, DEZINFECTARE APA



## Statii de deferizare cu respalare manuala, cu granulat BIRM

Model	Birm litri	Valva com./racordare	Debit m <sup>3</sup> /h	Suprafata m <sup>2</sup>	Debit respalare/timp	Greutate kg	Dim. (mm) l x l x i	Pret € /buc.
BlueSoft 1035BT-RX	24	RX-56F-MHF 1"	0.4-0.8	0.05	1.6 m <sup>3</sup> /h (7GPM) 20-6 min	55	300 x 300 x 1500	265,91

## Statii de deferizare cu respalare automata dupa timp valva de comanda model "RX", cu granulat BIRM

Model	Birm litri	Valva com./racordare	Debit m <sup>3</sup> /h	Suprafata m <sup>2</sup>	Debit respalare/timp	Greutate kg	Dim. (mm) l x l x i	Pret € /buc.
BlueSoft 1054BT-RX	43	RX-67B-DTF 1"	0.5-1.0	0.05	1.6 m <sup>3</sup> /h (7GPM) 20-6 min	70	300 x 300 x 1800	506,34
BlueSoft 1354BT-RX	71	RX-67B-DTF 1"	0.8-1.6	0.08	2.8 m <sup>3</sup> /h (12GPM) 20-6 min	105	400 x 400 x 1800	689
BlueSoft 1465BT-RX	85	RX-67B-DTF 1"	1.0-2.0	0.1	3.4 m <sup>3</sup> /h (15GPM) 20-6 min	140	420 x 420 x 2200	837,05
BlueSoft 1665BT-RX	114	RX-67B-DTF 1"	1.3-2.6	0.13	3.4 m <sup>3</sup> /h (15GPM) 20-6 min	180	450 x 450 x 2200	1006,32
BlueSoft 2162BT-RX	198	RX-75A-DTF 2"	2.2-4.4	0.22	5.7 m <sup>3</sup> /h (25GPM) 20-6 min	305	600 x 600 x 2300	2106,03
BlueSoft 2472BT-RX	255	RX-75A-DTF 2"	2.8-5.6	0.28	8.4 m <sup>3</sup> /h (37GPM) 20-6 min	385	700 x 700 x 2600	2706
BlueSoft 3072BT-RX	397	RX-75A-DTF 2"	4.4-8.8	0.44	13.6 m <sup>3</sup> /h (60GPM) 20-6 min	550	850 x 850 x 2600	3793,13

Echivalent fier (mg/l) = 1 x continut Fe (mg/l) + 2 x continut Mn (mg/l)

Determinarea vitezei de filtrare pe baza echivalentului de fier:

Echivalent fier	Viteza de filtrare
<0.2 mg/l	20 m/h
0.5 mg/l	18 m/h
1.0 mg/l	15 m/h
1.5 mg/l	12m/h
2.0 mg/l	10 m/h

Suprafata de filtrare necesara(m<sup>2</sup>) = Debit(m<sup>3</sup>/h) / Viteza de filtrare (m/h)

Intervalul de pH al apei: 6,8 – 9,0

Continutul oxigenului dizolvat trebuie sa fie cel putin 15% din continutul de fier.

Continutul clorului liber trebuie sa fie mai mic de 0,5 mg/l

Hidrogenul sulfurat trebuie indepartat inainte de a patrunde in filtru.



# PURIFICARE, DEDURIZARE, FILTRARE, DEZINFECTARE APA



## Statii de deferizare si demanganizare cu respalare manuala, cu granulat Pyrolox

Model	Pyrolox litri	Valva com./racordare	Debit m <sup>3</sup> /h	Suprafata m <sup>2</sup>	Debit respalare/timp	Greutate kg	Dim. (mm) l x l x i	Pret € /buc.
BlueSoft 1035PT-RX	23	RX-56F-MHF 1"	0.4-0.8	0.05	3.4 m <sup>3</sup> /h (15GPM) 20-6 min	60	300 x 300 x 1500	422,01

## Statii de deferizare si demanganizare cu valva de comanda dupa timp model "RX", cu granulat Pyrolox

Model	Pyrolox litri	Valva com./racordare	Debit m <sup>3</sup> /h	Suprafata m <sup>2</sup>	Debit respalare/timp	Greutate kg	Dim. (mm) l x l x i	Pret € /buc.
BlueSoft 1054PT-RX	23	RX-67B-DTF 1"	0.5-1.0	0.05	3.4 m <sup>3</sup> /h (15GPM) 20-6 min	75	300 x 300 x 1800	615,50
BlueSoft 1354PT-RX	46	RX-67B-DTF 1"	0.8-1.6	0.08	5.7 m <sup>3</sup> /h (25GPM) 20-6 min	130	400 x 400 x 1800	946,61
BlueSoft 1465PT-RX	57	RX-67B-DTF 1"	1.0-2.0	0.1	5.7 m <sup>3</sup> /h (25GPM) 20-6 min	200	420 x 420 x 2200	1165,40
BlueSoft 2162PT-RX	114	RX-75A-DTF 2"	2.2-4.4	0.22	11.1 m <sup>3</sup> /h (49GPM) 20-6 min	290	600 x 600 x 2300	2580,66
BlueSoft 2472PT-RX	148	RX-75A-DTF 2"	2.8-5.6	0.28	13.6 m <sup>3</sup> /h (60GPM) 20-6 min	410	700 x 700 x 2600	3458,16

Echivalent fier (mg/l) = 1 x continut Fe (mg/l) + 2 x continut Mn (mg/l)

Determinarea vitezei de filtrare pe baza echivalentului de fier:

Echivalent fier	Viteza de filtrare
<0.2 mg/l	20 m/h
0.5 mg/l	18 m/h
1.0 mg/l	15 m/h
1.5 mg/l	12m/h
2.0 mg/l	10 m/h

Suprafata de filtrare necesara(m<sup>2</sup>) = Debit(m<sup>3</sup>/h) / Viteza de filtrare (m/h)

Intervalul de pH al apei: 6,5 – 9,0

Volum liber min. 40% din inaltimea patului filtrant



# PURIFICARE, DEDURIZARE, FILTRARE, DEZINFECTARE APA



## Statie de deferizare si demanganizare (GreenSand) cu comanda dupa timp, model "RX"

Model	GreenSand kg	Valva com.	Debit m <sup>3</sup> /h	Suprafata m <sup>2</sup>	Debit respalare/timp	Greutate kg	Dim. (mm) l x l x i	Pret € /buc.
BlueSoft 1054KT-RX	43	RX-63B-DTS	0.5-1.0	0.05	1,6 m <sup>3</sup> /h (7GPM)	107	300 x 300 x 1800	699,21
BlueSoft 1354KT-RX	71	RX-63B-DTS	0.8-1.6	0.08	2,8 m <sup>3</sup> /h (12GPM)	161	400 x 400 x 1800	913,08
BlueSoft 1465KT-RX	85	RX-63B-DTS	1.0-2.0	0.1	3,4 m <sup>3</sup> /h (15GPM)	198	420 x 420 x 2200	1067,40
BlueSoft 1665KT-RX	114	RX-63B-DTS	1.3-2.6	0.13	3,4 m <sup>3</sup> /h (15GPM)	266	450 x 450 x 2200	1291,94
BlueSoft 2162KT-RX	198	RX-74A-DTS	2.2-4.4	0.22	5,7 m <sup>3</sup> /h (25GPM)	380	600 x 600 x 2300	2506,13

Echivalent fier (mg/l) = 1 x continut Fe (mg/l) + 2 x continut Mn (mg/l)  
 Determinarea vitezei de filtrare pe baza echivalentului de fier:

Echivalent fier	Viteza de filtrare
<0.2 mg/l	20 m/h
0.5 mg/l	18 m/h
1.0 mg/l	15 m/h
1.5 mg/l	12m/h
2.0 mg/l	10 m/h

Suprafata de filtrare necesara(m<sup>2</sup>) = Debit(m<sup>3</sup>/h) / Viteza de filtrare (m/h)

Intervalul de pH al apei: 6,2 – 8,5

Continutul clorului liber trebuie sa fie mai mic de 0,5 mg/l

Strat filtrant: 600-900mm

Volum liber min. 50% din inaltimea patului filtrant

Interzis continutul de ulei si polifosfati in apa bruta.

Regenerare: 2,5 – 3 g KMnO<sub>4</sub> / litru strat filtrant

Dizolvare KMnO<sub>4</sub>: In apa de 10°C: 30g KMnO<sub>4</sub> / litri H<sub>2</sub>O



# PURIFICARE, DEDURIZARE, FILTRARE, DEZINFECTARE APA



## Statie de dedurizare, deferizare si demanganizare (Crystal Right), comanda model "RX"

Model	Cristal Right litri / capacitate	Valva com./ racordare	Capac. m <sup>3</sup> /h	Supraf. m <sup>2</sup>	Debit respalare	Gre. kg	Volum rezervor saramura	Dim. (mm) l x l x i	Pret € /buc.
BlueSoft 1044CR-RX	28/ 47 m <sup>3</sup> x gG°	RX-63B-DVS + GYAF/ 1"	1.0-2.0	0.05	0,9 m <sup>3</sup> /h	60	85 litri	800 x 600 x 1400	1006,05
BlueSoft 1054CR-RX	43/ 73 m <sup>3</sup> x gG°	RX-63B-DVS + GYAF/ 1"	1.5-2.5	0.05	1,0 m <sup>3</sup> /h	75	85 litri	800 x 600 x 1600	1196,15
BlueSoft 1354CR-RX	71/ 120m <sup>3</sup> x gG°	RX-63B-DVS + GYAF/ 1"	2.0-3.5	0.08	1,7 m <sup>3</sup> /h	110	190 litri	900 x 600 x 1600	1717,43
BlueSoft 1465CR-RX	85/ 144m <sup>3</sup> x gG°	RX-63B-DVS + GYAF/ 1"	2.5-4.0	0.1	2,0 m <sup>3</sup> /h	145	190 litri	950 x 650 x 1800	2009,30

Detrminarea echivalentului de capacitate gG°

1mg Fe = 1 gG°

1mg Mn = 1 gG°

Conditii de functionare:

pH : 5 – 14,0

duritate totala: > 2,9 gG°

TDS: > 80 mg/l

Regenerarea aparatului se face cu tablete de sare.

Durata de viata rasina: 10 ani.



## Statie de dedurizare, deferizare, demanganizare si eliminare amoniac (Crystal Right), comanda "RX"

Model	Cristal Right litri	Valva com./ racordare	Capac. m <sup>3</sup> /h	Supraf. m <sup>2</sup>	Debit respalare	Gre. kg	Volum rezervor saramura	Dim. (mm) l x l x i	Pret € /buc.
BlueSoft 1044CR-RX	28	RX-63B-DVS + GYAF/ 1"	0,5	0.05	0,9 m <sup>3</sup> /h	60	80 litri	800 x 600 x 1400	1006,05
BlueSoft 1054CR-RX	43	RX-63B-DVS + GYAF/ 1"	0,6	0.05	1,0 m <sup>3</sup> /h	75	80 litri	800 x 600 x 1600	1196,15
BlueSoft 1354CR-RX	71	RX-63B-DVS + GYAF/ 1"	0,9	0.08	1,7 m <sup>3</sup> /h	110	130 litri	900 x 600 x 1600	1717,43
BlueSoft 1465CR-RX	85	RX-63B-DVS + GYAF/ 1"	1,0	0.1	2,0 m <sup>3</sup> /h	145	190 litri	950 x 650 x 1800	2009,30

Conditii de functionare:

viteza de filtrare: 10m/h

pH : 5 – 14,0

duritate totala: > 2,9 gG°

TDS: > 80 mg/l

Capacitate rasina: 980 mgNH<sub>3</sub><sup>+</sup> / litri Crystal Right

Regenerarea aparatului se face cu tablete de sare.

# PURIFICARE, DEDURIZARE, FILTRARE, DEZINFECTARE APA



## Statie pentru eliminare azotat uz casnic, cu cabinet, cu valva de comanda RX

Model	Rasina litri	Valva com./racordare	Capac. m <sup>3</sup> /h	Volum apa tratata intre doua regenerari	Gre. kg	Volum rezervor saramura	Dim. (mm) l x l x i	Pret € /buc.
BlueSoft 1035NT-RX	25	RX-63B-DVS 1"	0,7 - 1,5	225 / (NO <sub>3</sub> <sup>-</sup> +SO <sub>4</sub> <sup>2-</sup> ) 225 / (azotat+sulfat)	55	cabinet	320 x 500 x 1140	782,73

## Statii pentru eliminarea azotatilor, uz industrial, cu valva de comanda RX

Model	Rasina litri	Valva com./racordare	Capac. m <sup>3</sup> /h	Volum apa tratata intre doua regenerari	Gre. kg	Volum rezervor saramura	Dim. (mm) l x l x i	Pret € /buc.
BlueSoft 1054NT-RX	37	RX-63B-DVS 1"	1,0-2,0	330 / (NO <sub>3</sub> <sup>-</sup> +SO <sub>4</sub> <sup>2-</sup> ) 330 / (azotat+sulfat)	70	130 litri	800 x 600 x 1600	959,03
BlueSoft 1354NT-RX	62	RX-63B-DVS 1"	2,0-2,5	550 / (NO <sub>3</sub> <sup>-</sup> +SO <sub>4</sub> <sup>2-</sup> ) 550 / (azotat+sulfat)	105	190 litri	900 x 600 x 1600	1258,02
BlueSoft 1465NT-RX	87	RX-63B-DVS 1"	2,5-3,5	780 / (NO <sub>3</sub> <sup>-</sup> +SO <sub>4</sub> <sup>2-</sup> ) 780 / (azotat+sulfat)	140	340 litri	1100 x 700 x 1800	1748,30

## Statii pentru eliminare arsen, (material filtrant GEH), cu valva de comanda RX

Model	Rasina litri	Valva com./racordare	Capac. m <sup>3</sup> /h	Supraf. m <sup>2</sup>	Debit respalare m <sup>3</sup> /h	Gre. kg	Dim. (mm) l x l x i	Pret € /buc.
BlueSoft 1044AS-RX	30	RX-67B-DTS 1"	0,7-1,5	0,05	0,9 (4GPM)	75	300 x 300 x 1600	1195,25
BlueSoft 1354AS-RX	60	RX-67B-DTS 1"	1,2-2,0	0,08	1,6 (7GPM)	110	400 x 400 x 1600	2101,10
BlueSoft 1465AS-RX	90	RX-67B-DTS 1"	1,5-2,5	0,1	2,2 (10GPM)	145	420 x 420 x 1800	3027,36

### Conditii de functionare:

- viteza de filtrare: 15 – 35 m/h
- viteza de respalare: 15 – 25 m/h
- pH : 6,5 – 8,0
- pat filtrant: 600 – 900 mm
- volum liber: min 50% din inaltimea patului filtrant
- Capacitate rasina: 35gAS/litri - la pH7
- Capacitatea rasinii scade in prezenta fosfatilor.



# PURIFICARE, DEDURIZARE, FILTRARE, DEZINFECTARE APA



## Statii de desalinare totala

Model	Descriere	Debit litri/h	Capacitate intre doua regenerari la 20 gG°/apa tratata cu osmoza inversa RO	Cantitate rasina litri	Racordare	Pret € /buc.
BlueSoft 07-MB	Staie de desalinare totala	100	280/3500 litri	7	¾" / 1"	135,77
BlueSoft 15-MB	Staie de desalinare totala	150	600/7500 litri	15	¾" / 1"	221,52
BlueSoft 30-MB	Staie de desalinare totala	300	1200/15000 litri	30	¾" / 1"	340,94
BlueSoft 60-MB	Staie de desalinare totala	500	2400/30000 litri	60	¾" / 1"	582,87



Model	Descriere	Racordare sonda	Pret € /buc.
PV425	Aparat de masurat conductivitate apa cu sonda, cablu electric 1.5 m, transformator, lampa de control	3/8"	118,80

# PURIFICARE, DEDURIZARE, FILTRARE, DEZINFECTARE APA



## Statie de filtrare automata cu carbon activat cu comanda dupa timp, model RX

Model	Carbon activat	Comanda/racordare	Performanta m <sup>3</sup> /h	Suprafata m <sup>2</sup>	Debit respalare/timp	Gre. kg	Marimi l x l x i	Pret € /buc.
BlueSoft 1054AT-RX	45 litri	RX-67B-DTF 1"	0.5-1.0	0.05	1.1m <sup>3</sup> /h (5GPM) 20-6 min	42	300 x 300 x 1800	462,36
BlueSoft 1354AT-RX	72 litri	RX-67B-DTF 1"	0.8-1.6	0.08	1.6m <sup>3</sup> /h (7GPM) 20-6 min	70	400 x 400 x 1800	611,99
BlueSoft 1465AT-RX	90 litri	RX-67B-DTF 1"	1.0-2.0	0.1	2.3m <sup>3</sup> /h (10GPM) 20-6 min	85	420 x 420 x 2200	752,09
BlueSoft 1665AT-RX	120 litri	RX-67B-DTF 1"	1.3-2.6	0.13	2.9m <sup>3</sup> /h (13GPM) 20-6 min	110	450 x 450 x 2200	851
BlueSoft 2162AT-RX	180 litri	RX-75A-DTF 2"	2.2-4.4	0.22	5.7m <sup>3</sup> /h (25GPM) 20-6 min	170	600 x 600 x 2300	1884,51
BlueSoft 2472AT-RX	240 litri	RX-75A-DTF 2"	2.8-5.6	0.28	7.2m <sup>3</sup> /h (32GPM) 20-6 min	220	700 x 700 x 2600	2396,39
BlueSoft 3072AT-RX	360 litri	RX-75A-DTF 2"	4.4-8.8	0.44	12.5m <sup>3</sup> /h (55GPM) 20-6 min	330	850 x 850 x 2600	3741,66

## Statie de filtrare multimedie automata cu nisip quartos cu comanda dupa timp, model RX

Model	Pietris kg	Comanda/racordare	Performanta m <sup>3</sup> /h	Suprafata m <sup>2</sup>	Debit respalare/timp	Gre. kg	Marimi l x l x i	Pret € /buc.
BlueSoft 1054KT-RX	84	RX-67B-DTF 1"	0.5-1.0	0.05	1.6m <sup>3</sup> /h (7GPM) 20-6 min	95	300 x 300 x 1800	416,60
BlueSoft 1354KT-RX	132	RX-67B-DTF 1"	0.8-1.6	0.08	3.4m <sup>3</sup> /h (15GPM) 20-6 min	145	400 x 400 x 1800	538,28
BlueSoft 1465KT-RX	165	RX-67B-DTF 1"	1.0-2.0	0.1	3.4m <sup>3</sup> /h (15GPM) 20-6 min	180	420 x 420 x 2200	659,48
BlueSoft 1665KT-RX	215	RX-67B-DTF 1"	1.3-2.6	0.13	5.7m <sup>3</sup> /h (25GPM) 20-6 min	235	450 x 450 x 2200	710,25
BlueSoft 2162KT-RX	366	RX-75A-DTF 2"	2.2-4.4	0.22	8.4m <sup>3</sup> /h (37GPM) 20-6 min	395	600 x 600 x 2300	1717,79
BlueSoft 2472KT-RX	462	RX-75A-DTF 2"	2.8-5.6	0.28	11.1m <sup>3</sup> /h (49GPM) 20-6 min	495	700 x 700 x 2600	2161,22



# PURIFICARE, DEDURIZARE, FILTRARE, DEZINFECTARE APA



Model	Descriere	Dimensiuni	Volum litri	Diametru mm	Pret € /buc.
WC-PV006-T	Recipient de presiune PE, fara fusta	7 x 13 x 2.5"	5.8	182	39,86
WC-PV012-T	Recipient de presiune PE, fara fusta	8 x 17 x 2.5"	10.9	206	46,89
WC-PV014-T	Recipient de presiune PE, fara fusta	8 x 35 x 2.5"	24.8	206	65,61
WC-PV019-T	Recipient de presiune PE, fara fusta	9 x 35 x 2.5"	32.3	232	74,12
WC-PV022-T	Recipient de presiune PE, fara fusta	10 x 17 x 2.5"	16.8	257	49,82
WC-PV021-T	Recipient de presiune PE, fara fusta	10 x 30 x 2.5"	32.4	257	65,61
WC-PV024-T	Recipient de presiune PE, fara fusta	10 x 35 x 2.5"	38.8	257	85,05
WC-PV030-T	Recipient de presiune PE, cu fusta	7 x 17 x 2.5"	8.3	182	42,53
WC-PV032-T	Recipient de presiune PE, cu fusta	7 x 35 x 2.5"	19	182	63,54
WC-PV035-T	Recipient de presiune PE, cu fusta	8 x 17 x 2.5"	10.9	206	48,60
WC-PV037-T	Recipient de presiune PE, cu fusta	8 x 35 x 2.5"	24.8	206	70,23
WC-PV038-T	Recipient de presiune PE, cu fusta	8 x 44 x 2.5"	32.2	206	81,66
WC-PV042-T	Recipient de presiune PE, cu fusta	9 x 35 x 2.5"	32	232	80,55
WC-PV047-T	Recipient de presiune PE, cu fusta	10 x 17 x 2,5"	16.8	257	55,04
WC-PV048-T	Recipient de presiune PE, cu fusta	10 x 35 x 2.5"	38.8	257	91,13
WC-PV049-T	Recipient de presiune PE, cu fusta	10 x 44 x 2.5"	50	257	103,28
WC-PV050-T	Recipient de presiune PE, cu fusta	10 x 54 x 2.5"	63	257	111,78
WC-PV053-T	Recipient de presiune PE, cu fusta	12 x 48 x 2.5"	80	310	173,75
WC-PV057-T	Recipient de presiune PE, cu fusta	13 x 54 x 2.5"	105	335	208,98
WC-PV190-T	Recipient de presiune PE, cu fusta	14 x 65 x 2.5"	150	363	306,18
WC-PV192-T	Recipient de presiune PE, cu fusta	16 x 65 x 2.5"	194	413	348,71
WC-PV193-T	Recipient de presiune PE, cu fusta	16 x 65 x 4"	194	413	352,35
WC-PV195-T	Recipient de presiune PE, cu fusta	18 x 65 x 4"	257	486	578,34
WC-PV197-T	Recipient de presiune PE, cu fusta	21 x 62 x 4"	330	550	815,27
WC-PV199-T	Recipient de presiune PE, cu fusta	24 x 72 x 4"	473	626	1217,43

# PURIFICARE, DEDURIZARE, FILTRARE, DEZINFECTARE APA



Model	Descriere	Dimensiuni	Volum litri	Diametru mm	Pret € /buc.
WC-PV214-TB	Recipient de presiune PE, conexiune inferioara si superioara, cu fusta	16 x 65 x 4" x 4"	194	413	382,73
WC-PV215-TB	Recipient de presiune PE, conexiune inferioara si superioara, cu fusta	18 x 65 x 4" x 4"	257	486	646,38
WC-PV217-TB	Recipient de presiune PE, conexiune inferioara si superioara, cu fusta	21 x 62 x 4" x 4"	330	550	859,01
WC-PV219-TB	Recipient de presiune PE, conexiune inferioara si superioara, cu fusta	24 x 72 x 4" x 4"	473	626	1263,60
WC-PV220-TB	Recipient de presiune PE, conexiune inferioara si superioara, cu fusta	30 x 72 x 4" x 4"	700	780	1759,32
WC-PV221-TB	Recipient de presiune PE, conexiune inferioara si superioara, cu fusta	36 x 72 x 4" x 4"	1010	938	2223,45
WC-PV260-TB	Recipient de presiune PE, conexiune inferioara si superioara cu flansa, cu fusta	18 x 65 x 6" x 6"	261	485	866,30
WC-PV263-TB	Recipient de presiune PE, conexiune inferioara si superioara cu flansa, cu fusta	21 x 62 x 6" x 6"	330	549	1080,14
WC-PV266-TB	Recipient de presiune PE, conexiune inferioara si superioara cu flansa, cu fusta	24 x 72 x 6" x 6"	491	624	1409,40
WC-PV269-TB	Recipient de presiune PE, conexiune inferioara si superioara cu flansa, cu fusta	30 x 72 x 6" x 6"	674	779	1919,70
WC-PV272-TB	Recipient de presiune PE, conexiune inferioara si superioara cu flansa, cu fusta	36 x 72 x 6" x 6"	970	931	2357,10
WC-PV276-TB	Recipient de presiune PE, conexiune inferioara si superioara cu flansa, cu fusta	42 x 72 x 6" x 6"	1494	1089	3402,00
WC-PV279-TB	Recipient de presiune PE, conexiune inferioara si superioara cu flansa, cu fusta	48 x 72 x 6" x 6"	1895	1233	4301,10
WC-PV273-TB	Recipient de presiune PE, conexiune inferioara si superioara cu flansa, cu fusta	63 x 67 x 6" x 6"	2590	1625	5503,95
WC-PV274-TB	Recipient de presiune PE, conexiune inferioara si superioara cu flansa, cu fusta	63 x 86 x 6" x 6"	3280	1625	6087,15

# PURIFICARE, DEDURIZARE, FILTRARE, DEZINFECTARE APA

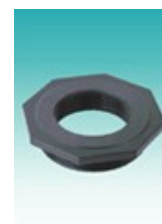
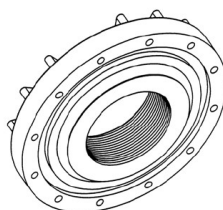
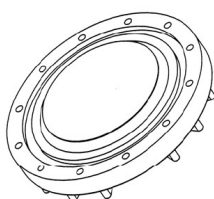
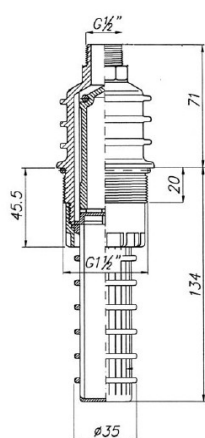

Model	Descriere	Pret € /buc.
502-DT-2	Dop 4"	6,87
506-DT-4	Flansa de inchidere 6"	29,87
504-BJ-1	Transformator cu filet 4"- 2,5"	6,87
505-BJ-2	Transformator cu filet 6"- 4"	11,34
WC-PV308	Supapa de aerisire si vacuum	113,31

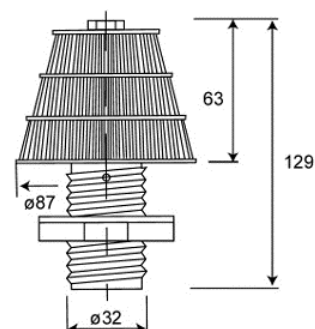
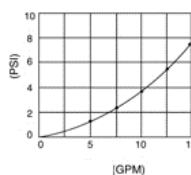
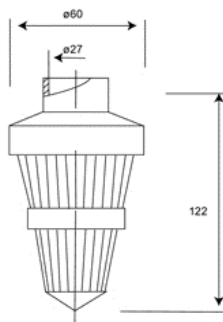
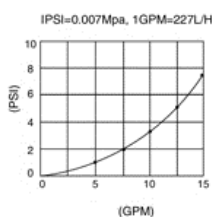
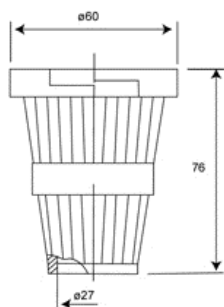

Model	Descriere	Dimensiuni rezervor	Marimea deschizaturii	Pret € /buc.
210-25-TM-0.25*	Distribuator inferior d25	6-12"	0.25mm	1,41
209-25-TM-0.25*	Distribuator superior d25	6-12"	0.25mm	1,41
210-32-TM-0.25*	Distribuator inferior d32	6-16"	0.25mm	1,41
220-32-TM-0.25*	Distribuator superior d32	6-16"	0.25mm	1,41
201-TM-0.25*	Filtru inferior	1m3/h	0.25mm	3,57

# PURIFICARE, DEDURIZARE, FILTRARE, DEZINFECTARE APA

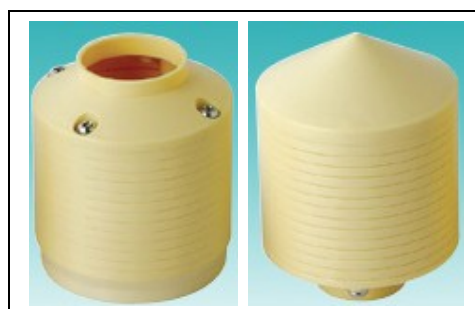
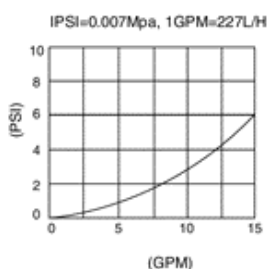
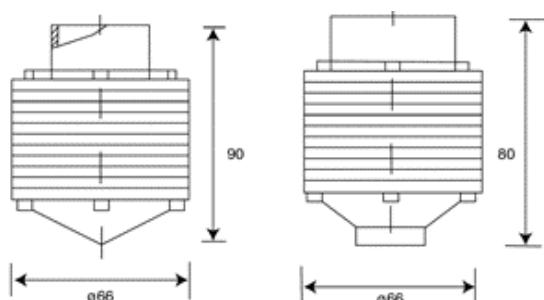

Model	Descriere	Dimensiuni rezervor	Marimea deschizaturii	Pret € /buc.
214-32-TM-0.25*	Distribuator inferior d32	8-16"	0.25mm	5,19
213-32-TM-0.25*	Distribuator superior d32	8-16"	0.25mm	5,19

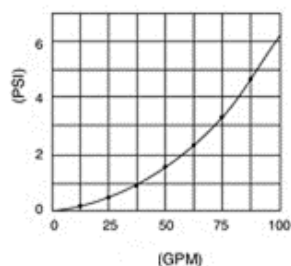
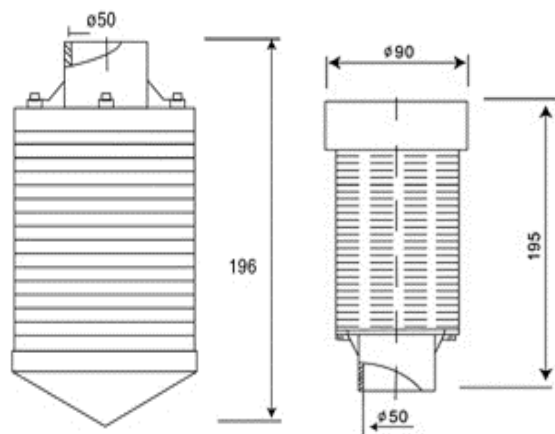

Model	Descriere	Dimensiuni rezervor	Marimea deschizaturii	Pret € /buc.
218-50-TM-0.25*	Distribuator inferior d50	12-36"	0.25mm	17,94
216-50-TM-0.25*	Distribuator superior d50	12-36"	0.25mm	17,94

# PURIFICARE, DEDURIZARE, FILTRARE, DEZINFECTARE APA

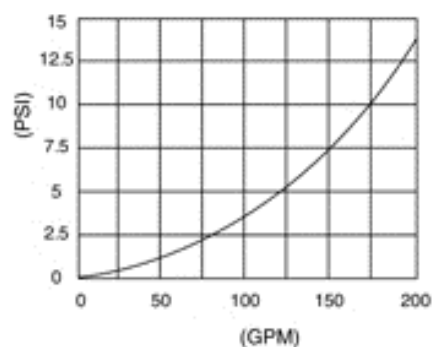
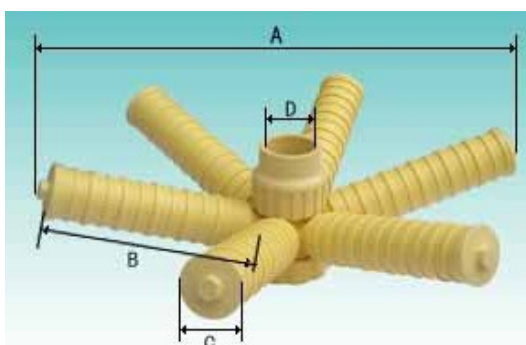

Model	Descriere	Dimensiuni rezervor	A	B	C	Marimea deschizaturii	Pret € /buc.
324-50-TM-0.25	Distribuator inferior d50 ; 6 brate	13 - 16"	260	82	53	0.25mm	32,84
306-50-TM-0.25	Distribuator inferior d50 ; 6 brate	18 - 21"	370	136	53	0.25mm	37,92
307-50-TM-0.25	Distribuator inferior d50 ; 6 brate	24"	450	182	53	0.25mm	42,71
308-63-TM-0.25	Distribuator inferior d50/63 ; 6 brate	30"	620	260	53	0.25mm	49,89
309-63-TM-0.25	Distribuator inferior d50/63 ; 6 brate	36 - 42"	710	330	53	0.25mm	64,20
326-63-TM-0.25	Distribuator inferior d63 ; 2 x 6 brate	36 - 42"	710	330	53	0.25mm	137,96
327-63-TM-0.25	Distribuator inferior d63 ; 2 x 6 brate	48"	930	410	53	0.25mm	176,13

# PURIFICARE, DEDURIZARE, FILTRARE, DEZINFECTARE APA

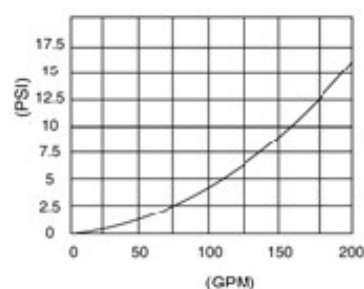
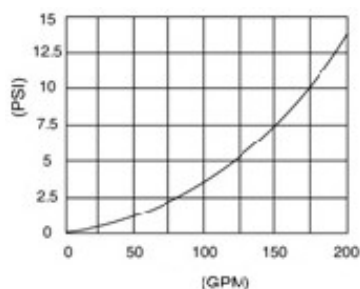
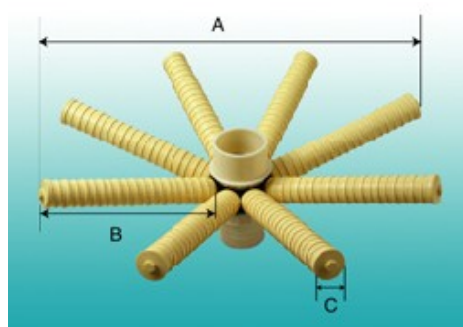

Model	Descriere	Dimensiuni rezervor	A	B	C	Marimea deschizaturii	Pret € /buc.
401-90-TM-0.25	Distribuator inferior d90 ; 8 brate	24"	512	190	53	0.25mm	92,57
402-90-TM-0.25	Distribuator inferior d90 ; 8 brate	30"	630	256	53	0.25mm	107,49
403-90-TM-0.25	Distribuator inferior d90 ; 8 brate	36"	750	318	53	0.25mm	122,43
411-90-TM-0.25	Distribuator inferior d90 ; 8 brate	42"	870	380	53	0.25mm	206,01
412-63-TM-0.25	Distribuator inferior d90 ; 2 x 8 brate	48"	980	445	53	0.25mm	235,88
413-63-TM-0.25	Distribuator inferior d90 ; 2 x 8 brate	63"	1218	564	53	0.25mm	271,70

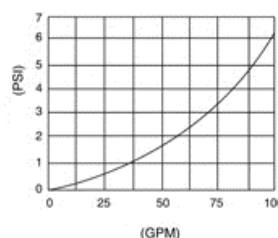
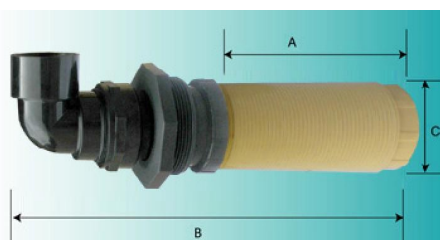

Model	Descriere	Dimensiuni rezervor	A	B	C	Marimea deschizaturii	Pret € /buc.
311-63-SM-0.25	Distribuator superior d63	14 - 30"	180	400	88	0.25mm	40,31
312-63-SM-0.25	Distribuator superior d63	21 - 36"	242	472	88	0.25mm	59,70
313-63-SM-0.25	Distribuator superior d63	30 - 36"	310	540	88	0.25mm	71,64

**Preturile nu includ TVA.  
Preturile nu includ transportul**

# PURIFICARE, DEDURIZARE, FILTRARE, DEZINFECTARE APA

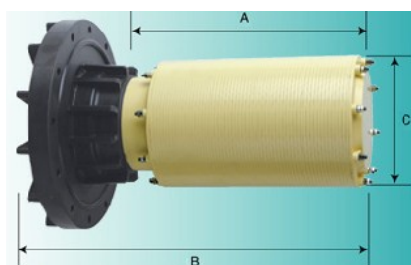

Model	Descriere	Dimensiuni rezervor	A	B	C	Marimea deschizaturii	Pret € /buc.
415-90-SM-0.25	Distribuator superior d90	42 - 48"	260	360	140	0.25mm	122,43
416-90-SM-0.25	Distribuator superior d90	48 - 64"	330	420	140	0.25mm	137,33
417-90-SM-0.25	Distribuator superior d90	64 - 80"	430	520	140	0.25mm	167,19

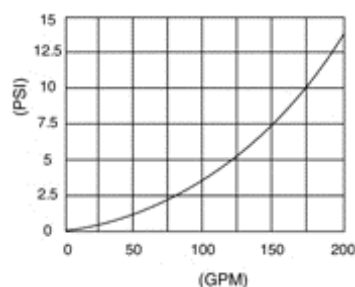
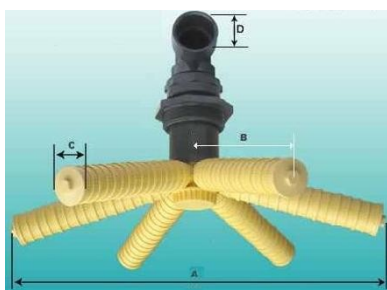

Model	Descriere	Dimensiuni rezervor	A	B	C	Marimea deschizaturii	Pret € /buc.
325-63-SM-0.25	Distribuator superior d63	13-16"	260	82	53	0.25mm	45,68
319-63-SM-0.25	Distribuator superior d63	18-21"	370	136	53	0.25mm	52,56
320-63-SM-0.25	Distribuator superior d63	24"	450	182	53	0.25mm	64,20
321-63-SM-0.25	Distribuator superior d63	30"	620	260	53	0.25mm	78,21
322-63-SM-0.25	Distribuator superior d63	36-42"	710	330	53	0.25mm	96,15
329-63-SM-0.25	Distribuator superior d63	48"	930	410	53	0.25mm	206,01

# PURIFICARE, DEDURIZARE, FILTRARE, DEZINFECTARE APA

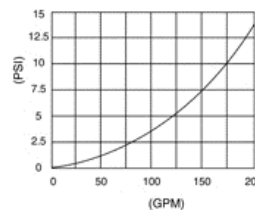
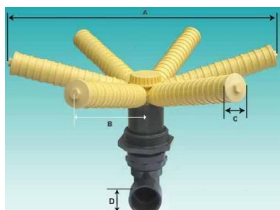

Model	Descriere	Dimensiuni rezervor	A	B	C	Marimea deschizaturii	Pret € /buc.
325-63-SM-0.25	Distribuator inferior d63 ; 6 brate	13 - 16"	260	82	53	0.25mm	45,68
319-63-SM-0.25	Distribuator inferior d63 ; 6 brate	18 - 21"	370	136	53	0.25mm	52,56
320-63-SM-0.25	Distribuator inferior d63 ; 6 brate	24"	450	82	53	0.25mm	64,20
321-63-SM-0.25	Distribuator inferior d63 ; 6 brate	30"	620	260	53	0.25mm	78,21
322-63-SM-0.25	Distribuator inferior d63 ; 6 brate	36 - 42"	710	330	53	0.25mm	96,15
328-63-SM-0.25	Distribuator inferior d63 ; 2 x 6 brate	36 - 42"	710	330	53	0.25mm	169,59
329-63-SM-0.25	Distribuator inferior d63 ; 2 x 6 brate	48"	930	410	53	0.25mm	206,01

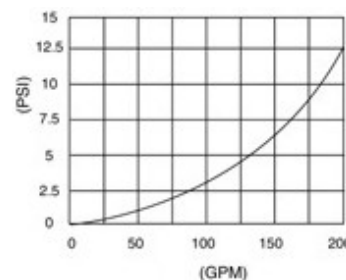
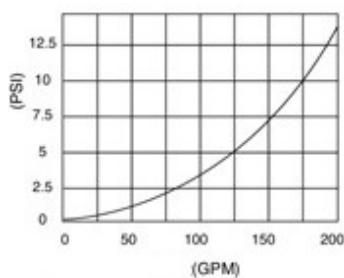
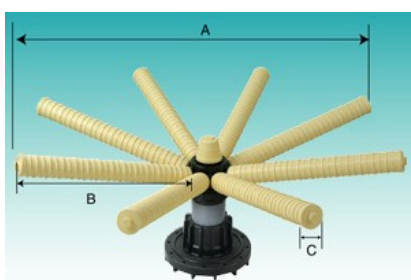

Model	Descriere	Dimensiuni rezervor	A	B	C	Marimea deschizaturii	Pret € /buc.
418-90-SM-0.25	Distribuator inferior d90 ; 8 brate	24"	512	190	53	0.25mm	116,45
419-90-SM-0.25	Distribuator inferior d90 ; 8 brate	30"	630	256	53	0.25mm	128,39
420-90-SM-0.25	Distribuator inferior d90 ; 8 brate	36"	750	318	53	0.25mm	137,33
421-90-SM-0.25	Distribuator inferior d90 ; 8 brate	42"	870	380	53	0.25mm	155,25
429-63-SM-0.25	Distribuator inferior d90 ; 2 X 8 brate	48"	980	445	53	0.25mm	253,76
430-63-SM-0.25	Distribuator inferior d90 ; 2 x 8 brate	63"	1218	564	53	0.25mm	283,64

# PURIFICARE, DEDURIZARE, FILTRARE, DEZINFECTARE APA

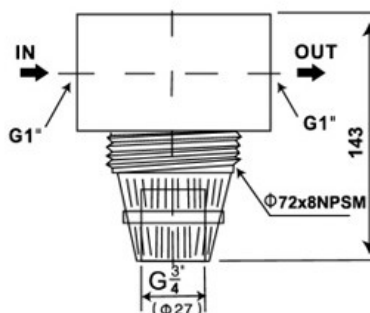

Model	Descriere	Debit / Respalare	Dimensiuni rezervor	Racordare intr/ies	Racordare apa rez.	Pret € /buc.
RX-ATF	Valva de comanda cu filtru superior si inferior	2,5 m <sup>3</sup> /h 2,5 m <sup>3</sup> /h	6-12"	1"	1"	9,54
RX-56F-MHF	Aparat de control al filtrului manual, conexiune de 2,5", cu filtru superior si inferior	6m <sup>3</sup> /h 6m <sup>3</sup> /h	6-16"	1"	1"	26,37
RX-56D-MHF/TM	Aparat de control al filtrului manual, conexiune de 4",montare superioara, cu filtru superior si inferior	10m <sup>3</sup> /h 10m <sup>3</sup> /h	14-30"	2"	1 1/2"	157,14
RX-56D-MHF/SM	Aparat de control al filtrului manual, conexiune de 4",montare laterala	10m <sup>3</sup> /h 10m <sup>3</sup> /h	14-30"	2"	1 1/2"	175,05



RX-56F-MHF



RX-56D-MHF/TM



RX-56D-MHF/SM

# PURIFICARE, DEDURIZARE, FILTRARE, DEZINFECTARE APA



Model	Descriere	Debit / Respalare	Dimensiuni rezervor	Racordare intr/ies	Racordare apa rez.	Pret € /buc.
RX-67B-DTF	Valva de comanda ptr. statii de filtrare, automat dupa timp, racordare 2.5", cu filtru superior si inferior	6m <sup>3</sup> /h 6m <sup>3</sup> /h	6-16"	1"	1"	159,30
RX-75A-DTF	Valva de comanda ptr. statii de filtrare, automat dupa timp, racordare 4", cu filtru superior si inferior	10m <sup>3</sup> /h 10m <sup>3</sup> /h	14-36"	2"	1 1/2"	446,13



RX-67B-DTF



RX-75A-DTF

Model	Descriere	Debit / Respalare	Dimensiuni rezervor	Racord. intr/ies	Racord. apa rez.	Pret € /buc.
RX-64A-MHS	Valva de comanda ptr. statii de dedurizare manuala, conexiune 2.5", cu filtru superior si inferior, racord cu cot 3/8"	4,5m <sup>3</sup> /h 3,5m <sup>3</sup> /h	6-18"	1"	1/2"	64,52
RX-64D-MHS/TM	Valva de comanda ptr. statii de dedurizare manuala, conexiune 4", montare superioara, cu filtru superior si inferior	10m <sup>3</sup> /h 6m <sup>3</sup> /h	14-30"	2"	1"	311,45
RX-64D-MHS/SM	Valva de comanda ptr. statii de dedurizare manuala, conexiune 4", montare laterala,	10m <sup>3</sup> /h 6m <sup>3</sup> /h	14-30"	2"	1"	329,25
RX-65C-DHS	Valva de comanda ptr. statii de dedurizare, semi-automat, cu filtru superior si inferior, racord cu cot 3/8"	2m <sup>3</sup> /h 2m <sup>3</sup> /h	6-12"	3/4"	1/2"	98,00
RX-ADJ	Unitate pt. programare valva de comanda RX-65C-DHS (prin port USB)	-	-	-	-	19,61



RX-64A-MHS



RX-64D-MHS/TM



RX-64D-MHS/SM



RX-65C-DHS

# PURIFICARE, DEDURIZARE, FILTRARE, DEZINFECTARE APA



Model	Descriere	Debit / Respalare	Dimensiuni rezervor	Racordare intr/ies	Racordare apa rez.	Pret € /buc.
RX-65B-DTS	Valva de comanda ptr. statii de dedurizare, digitala automat dupa timp, cu filtru superior si inferior, racord cu cot 3/8"	2m <sup>3</sup> /h 2m <sup>3</sup> /h	6-12"	3/4"	1/2"	148,59
RX-65A-DVS	Valva de comanda ptr. statii de dedurizare, digitala automat volumetric, cu filtru superior si inferior, racord cu cot 3/8"	2m <sup>3</sup> /h 2m <sup>3</sup> /h	6-12"	3/4"	1/2"	170,33
RX-65B-DVS	Valva de comanda ptr. statii de dedurizare, digitala automat volumetric, cu filtru superior si inferior, racord cu cot 3/8", valva by-pass	2m <sup>3</sup> /h 2m <sup>3</sup> /h	6-12"	3/4"	1/2"	184,23
RX-63B-DTS	Valva de comanda ptr. statii de dedurizare, digitala automat dupa timp, cu filtru superior si inferior, racord cu cot 3/8"	4,5m <sup>3</sup> /h 3,5m <sup>3</sup> /h	6-18"	1"	1/2"	192,06
RX-63B-DVS	Valva de comanda ptr. statii de dedurizare, digitala automat volumetric, cu filtru superior si inferior, racord cu cot 3/8", cu valva by-pass	4,5m <sup>3</sup> /h 3,5m <sup>3</sup> /h	6-18"	1"	1/2"	231,26
RX-79B-DVS	Valva de comanda ptr. statii de dedurizare cu regenerare in contracurent, digitala automat volumetric, cu filtru superior si inferior, racord cu cot 3/8"	2m <sup>3</sup> /h 2m <sup>3</sup> /h	6-18"	3/4"	1/2"	198,84



RX-65B-DTS



RX-65A-DVS



RX-63B-DTS



RX-63B-DVS

# PURIFICARE, DEDURIZARE, FILTRARE, DEZINFECTARE APA



Model	Descriere	Debit / Respalare	Dimensiuni rezervor	Racor. intr/ies	Racor. apa rez.	Pret € /buc.
RX-74A-DTS	Valva de comanda ptr. statii de dedurizare digitala automata dupa timp cu filtru superior si inferior, racord cu cot 1/2"	10 m <sup>3</sup> /h	14-30"	2"	1"	548,04
RX-74A-DVS	Valva de comanda ptr. statii de dedurizare digitala automata volumetric cu filtru superior si inferior, racord cu cot 1/2"	10 m <sup>3</sup> /h	14-30"	2"	1"	583,32
RX-77A-DVS	Valva de comanda ptr. statii de dedurizare digitala automata volumetric	18 m <sup>3</sup> /h	21-42"	2"	1 1/2 "	923,27
RX-78SM-DVS	Valva de comanda ptr. statii de dedurizare digitala automata volumetric, montare laterala	40 m <sup>3</sup> /h	30-63"	DN65 (d75)	DN65 (d75)	1716,83



RX-74A-DVS



RX-77A-DVS



RX-78SM-DVS

Model	Descriere	Debit / Respalare	Dimensiuni rezervor	Racor. intr/ies	Racor. apa rez.	Pret € /buc.
RX-73AB-DVS	Valva de comanda ptr. statii de dedurizare duplex, digitala automata volumetric cu filtru superior si inferior, racord cu cot 3/8"	3,5m <sup>3</sup> /h 3,5m <sup>3</sup> /h	6-16"	1"	1/2"	484,61
RX-74AB-DVS	Valva de comanda ptr. statii de dedurizare duplex, digitala automata volumetric cu filtru superior si inferior, cu mecanism de schimbare, racord cu cot 1/2"	10 m <sup>3</sup> /h	14-30"	2"	1"	2020,08
V3063	Supapa 3 directii, cu motor	20 m <sup>3</sup> /h	-	2"	-	569,70



RX-73AB-DVS



V3063

# PURIFICARE, DEDURIZARE, FILTRARE, DEZINFECTARE APA



Model	Descriere	Dimensiuni mm l x l x i	Pret € /buc.
G1015-20	Rezervor KmnO <sub>4</sub> , cu grila si valva ptr. sare	20 litri	106,32
G1015-72	Rezervor KmnO <sub>4</sub> , cu grila si valva ptr. sare	72 litri	167,07
G1015-125	Rezervor KmnO <sub>4</sub> , cu grila si valva ptr. sare	125 litri	197,67
BT603-25	Rezervor saramura complet cu grila, tub de protectie, 25 litri		27,86
BT601-80	Rezervor saramura complet cu grila, tub de protectie, 80 litri	350 x 350 x 885	51,56
BT602-130	Rezervor saramura complet cu grila, tub de protectie, 130 litri	350 x 350 x 1085	58,53
PC005	Rezervor saramura, 85 litri	380 x 380 x 790	40,17
PC027	Rezervor saramura, 190 litri	500 x 500 x 1080	116,54
PC040	Rezervor saramura, 340 litri	635 x 635 x 1150	196,56
PC045	Rezervor saramura, 460 litri,	692 x 692 x 1150	294,84
PC060	Rezervor saramura, 670 litri	835 x 835 x 1150	407,16
PC065	Rezervor saramura, 920 litri	1035 x 1035 x 1150	544,76
PC006	Grila sare, ptr rezervor de 85 litri	-	19,38
PC031	Grila sare, ptr rezervor de 190 litri	-	15,74
PC070	Grila sare, ptr rezervor de 340 litri	-	89,87
PC071	Grila sare, ptr rezervor de 460 litri	-	95,48
PC072	Grila sare, ptr rezervor de 670 litri	-	154,44
PC073	Grila sare, ptr rezervor de 920 litri	-	165,68
PA007	Tub de protectie ptr. rezervor de 85 litri	-	9,44
PA015	Tub de protectie ptr. rezervor de 190 litri	-	11,79
PA016	Tub de protectie ptr. rezervor de 340 - 920 litri	-	24,17
PA022	Cabinet Mini	435 x 240 x 340	50,54
PA210	Cabinet Mini Crystal	500 x 320 x 670	75,83
PA235	Cabinet Maxi Crystal	500 x 320 x 1140	109,52
PA540	Cabinet New Mini Ocean	500 x 320 x 670	81,44
PA520	Cabinet New Midi Ocean	500 x 320 x 1010	101,79
PA525	Cabinet New Maxi Ocean	500 x 320 x 1140	115,14

# PURIFICARE, DEDURIZARE, FILTRARE, DEZINFECTARE APA



434-BV

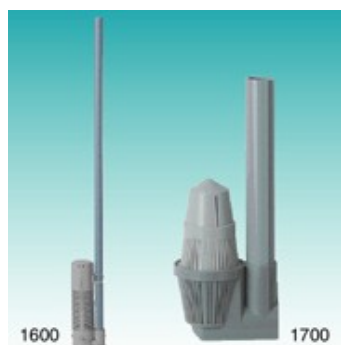

1600

1600-BV

1700

1700-BV

Model	Descriere	Pret € /buc.
1600-BV	Air Check cu cot 3/8"	6,03
1700-BV	Air Check 1/2"	11,52
434-BV	Supapa saramura cu cot 3/8"	17,01
454-BV	Supapa saramura 1/2"	83,75
H7001	Cot ptr. absorbire saramura 3/8" x 3/8"	3,05
H7000	Cot 'preaplin' pentru saramura	3,05
I8065-1	Furtun ptr. absorbirea saramura 3/8"	3,41
I8081	Furtun ptr. absorbirea saramura 1/2"	6,80



BIRM



PYROLOX



GREENSAND



MTM

Model	Descriere	Cantitate/ sac	Pret € /litru
A8006	Birm pentru reducerea continutului de fier si mangan	28,3 litri	3,09
A8030	Pyrolox pentru reducerea continutului de fier si mangan	23 kg. 11,32 litri	9,14
A8041	Nisip verde plus pentru reducerea continutului de fier si mangan	14,2 litri	4,37
A9050	MTM sintetic, pentru reducerea continutului de fier si mangan	28,3 litri	3,92
A9033	Carbon activat Organosorb	52 litri	1,80
RA061	Anthracite	25 kg. 26,4 litri	1,89
RA068	Granulat neutralizant de arsen	33 kg. 30 litri	25,46
SK-2-4*	Pietris 2-4 mm	25 kg.	0,51
SK-1-2*	Pietris 1-2 mm	20 kg.	0,51
SK-0,5-1,2*	Pietris 0.5-1.2mm	20 kg.	0,51
SK-0,4-0,8*	Pietris 0.4-0.8mm	20 kg.	0,51

# PURIFICARE, DEDURIZARE, FILTRARE, DEZINFECTARE APA



Pure



Crystal Right

Model	Descriere	Cantitate/sac	Unitate	Pret € /litru
PC002	Pure 002 – schimbator cationic acidos puternic	25 litri	litri	2,75
PA103OH	Pure 103 – schimbator anionic alcalin puternic	25 litri	litri	7,50
PMB101-2	Pure 101 – rasina schimbator selectiv de ioni	25 litri	litri	5,36
PA202	Pure 202 – rasina schimbator selectiv de ioni pt. eliminare azotati	25 litri	sac	11.84
AS-CR100	Crystal Right CR100/200 rasina pt. Eliminarea amoniac, fier, mangan, calcar	28.3 litri	butoi	10,34

Model	Descriere	Performanta litri/h	Membrana	Pret € /buc.
ECSRO 60G	Instalatie de desalinare cu membrana de osmoza inversa, cu prefiltru, filtru de carbon activ, manometru, cu rezervor de acumulare (puffer) de 42 litri, montata pe un suport PP	60 - 80	1 x 2.5"x40"	4071,42
ECSRO 120G	Instalatie de desalinare cu membrana de osmoza inversa, cu prefiltru, filtru de carbon activ, manometru, cu rezervor de acumulare (puffer) de 42 litri, montata pe un suport PP	120 - 160	2 x 2.5"x40"	4712,21



ECSRO

VTSRO

# PURIFICARE, DEDURIZARE, FILTRARE, DEZINFECTARE APA



Model	Descriere	Performanta litri/h	Membrana buc. x dimensiuni	Pret € /buc.
VTSRO 200G	Instalatie de desalinare cu membrana de osmoza inversa, cu prefiltru BigBlue, filtru de carbon activ BigBlue,rotametrul, manometrul, montata pe cadru din otel de calitate, fara membrana.	200 - 300	1 x 4"x40"	6219,83
VTSRO 400G	Instalatie de desalinare cu membrana de osmoza inversa, cu prefiltru BigBlue, filtru de carbon activ BigBlue,rotametrul, manometrul, montata pe cadru din otel de calitate, fara membrana.	400 - 600	2 x 4"x40"	6775,65
VTSRO 600G	Instalatie de desalinare cu membrana de osmoza inversa, cu prefiltru BigBlue, filtru de carbon activ BigBlue,rotametrul, manometrul, montata pe cadru din otel de calitate, fara membrana.	600 - 900	3 x 4"x40"	7460,64
VTSRO 800G	Instalatie de desalinare cu membrana de osmoza inversa, cu prefiltru BigBlue, filtru de carbon activ BigBlue,rotametrul, manometrul, montata pe cadru din otel de calitate, fara membrana.	800 - 1200	4 x 4"x40"	7796,07

Model	Descriere	Dimensiuni	Retinere saruri	Capacitate/ presiune de lucru	Pret € /buc.
VTSRO 1200G	Instalatie de desalinare cu membrana de osmoza inversa, cu prefiltru BigBlue, filtru de carbon activ BigBlue,rotametrul, manometrul, montata pe cadru din otel de calitate, fara membrana.				
ULP-50	Membrana de osmoza inversa RO ULP	1,8"x 12"	97%	50 GPM/60 PSI (189 l/zi / 4,1 bari)	44,40
ULP-75	Membrana de osmoza inversa RO ULP	1,8"x 12"	97%	75 GPM/60 PSI (283 l/zi / 4,1 bari)	46,26
ULP-100	Membrana de osmoza inversa RO ULP	2"x12"	95%	100 GPM/60 PSI (378 l/zi / 4,1 bari)	51,42
ULP-300	Membrana de osmoza inversa RO ULP	3"x12"	95%	300 GPM/75 PSI (1134 l/zi / 5,2 bari)	144,90

Preturile n  
Preturile n



ULP

# PURIFICARE, DEDURIZARE, FILTRARE, DEZINFECTARE APA



Model	Model	Dimensiuni	Retinere saruri	Capacitate/ presiune de lucru	Suprafata membrana	Pret € /buc.
ULP-21-2521	Membrana de osmoza inversa RO	2,5 x 21"	99%	300 GPM/150 PSI (1134 l/zi / 10,3 bari)	1,1 m <sup>2</sup>	144,90
ULP-21-2540	Membrana de osmoza inversa RO	2,5 x 40"	99%	750 GPM/150 PSI (2840 l/zi / 10,3 bari)	2,6 m <sup>2</sup>	226,92
ULP-21-4021	Membrana de osmoza inversa RO	4" x 21"	99%	950 GPM/150 PSI (3600 l/zi / 10,3 bari)	3,3 m <sup>2</sup>	246,05
ULP-21-4040	Membrana de osmoza inversa RO	4" x 40"	99%	2500 GPM/150 PSI (9500 l/zi / 10,3 bari)	7,9 m <sup>2</sup>	349,92

ULP-31-4040	Membrana de osmoza inversa RO	4" x 40"	99,4%	1900 GPM/150 PSI (7200 l/zi / 10,3 bari)	7,9 m <sup>2</sup>	349,92
LP-21-4040	Membrana de osmoza inversa RO	4" x 40"	99,5%	2400 GPM/225 PSI (9100 l/zi / 15,5 bari)	7,9 m <sup>2</sup>	341,73
SW-21-4040	Membrana de osmoza inversa RO	4" x 40"	99%	1200 GPM/max.1000 PSI (4500 l/zi / max. 69 bari)	7,4 m <sup>2</sup>	451,08
ULP-22-8040	Membrana de osmoza inversa RO	8" x 40"	99,5%	12100 GPM/150 PSI (45.700 l/zi / 10,3 bari)	37 m <sup>2</sup>	1066,17

# PURIFICARE, DEDURIZARE, FILTRARE, DEZINFECTARE APA



ULP-32-8040	Membrana de osmoza inversa RO	8" x 40"	99,5%	10500 GPM/150 PSI (39.700 l/zi / 10,3 bari)	37 m <sup>2</sup>	1079,84
LP-21-8040	Membrana de osmoza inversa RO	8" x 40"	99,5%	9600 GPM/225 PSI (36.300l/zi / 15,5 bari)	33,9 m <sup>2</sup>	1052,51
LP-22-8040	Membrana de osmoza inversa RO	8" x 40"	99,5%	10500 GPM/225 PSI (39.700 l/zi / 15,5 bari)	37 m <sup>2</sup>	1066,17
SW-22-8040	Membrana de osmoza inversa RO	8" x 40"	99,7%	6000 GPM/ max.1000 PSI (22.700 l/zi / max. 69 bari)	35,2 m <sup>2</sup>	1325,88

**RX-56F-MHF**

**RX-56D-MHF/TM**

**RX-56D-MHF/SM**

**ULP**- ULTRA LOW PRESSURE (Presiune ultra scazuta)

**LP** - LOW PRESSURE (Presiune scazuta)

**SW** - SEA WATER (Apa marii)



YT



BNSS

Model	Descriere	Material carcasa membrana	Dimensiuni	Presiune bar	Pret € /buc.
DE608	Carcasa membrana de osmoza cu dop	Fibra de sticla	4" x 21"	21	191,37
DE600 YT-25	Carcasa membrana de osmoza cu dop	Fibra de sticla EPDM	(1,8" x 24" x 12"	21	235,11 8,31
DE602	Carcasa membrana de osmoza cu dop	Fibra de sticla	4" x 80"	21	317,12
DE604	Carcasa membrana de osmoza cu dop	Fibra de sticla	4" x 120"	21	415,53
EA300	Carcasa membrana de osmoza cu dop	Fibra de sticla	8" x 40"	21	1182,36
EA301	Carcasa membrana de osmoza cu dop	Fibra de sticla	8" x 80"	21	1291,71
EA302	Carcasa membrana de osmoza cu dop	Fibra de sticla	8" x 120"	21	1401,06
EA303	Carcasa membrana de osmoza cu dop	Fibra de sticla	8" x 160"	21	1510,71
EA304	Carcasa membrana de osmoza cu dop	Fibra de sticla	8" x 200"	21	1619,76
EA305	Carcasa membrana de osmoza cu dop	Fibra de sticla	8" x 240"	21	1729,11

**Preturile nu includ TVA.  
Preturile nu includ transpo**

**Resina: 4E**

# PURIFICARE, DEDURIZARE, FILTRARE, DEZINFECTARE APA



EA

DE

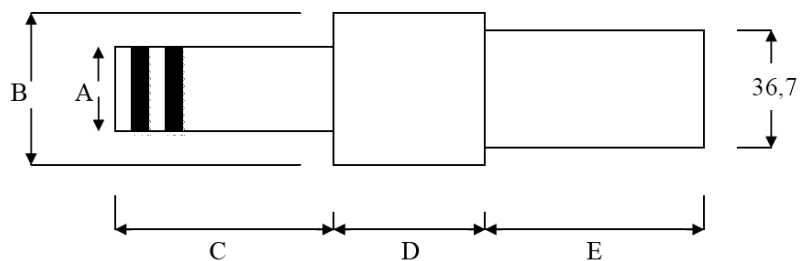

Model	Descriere	A mm	B mm	C mm	D mm	E mm	Pt. membrana	Pt. carcasa membran	O ring	Pret € /buc.
EA340	Adaptor membrana	28,5 / 1,125"	48	65	45	67	BW30-400 ori asemanator	Wave Cyber	EA354	28,71
EA341	Adaptor membrana	38 / 1,5"	58	50	45	67	BW30LE440 ori asemanator	Wave Cyber	EA355	43,74
EA025	Adaptor membrana	28,5 / 1,125"	48	65	27	73	BW30-400 ori asemanator	Wave Cyber	EA354	35,55

Prețurile nu includ transportul.

# PURIFICARE, DEDURIZARE, FILTRARE, DEZINFECTARE APA

